

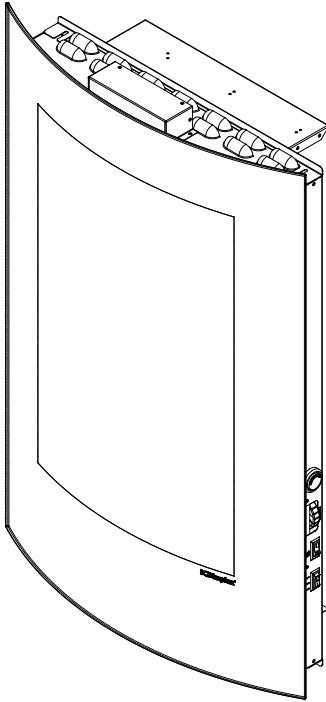

Better solutions through innovation



Owner's Manual

Model

VCX1525

VCX1525-WH







IMPORTANT SAFETY INFORMATION: Always read this manual first before attempting to install or use this fireplace. For your safety, always comply with all warnings and safety instructions contained in this manual to prevent personal injury or property damage.

To view the full line of Dimplex products, please visit www.dimplex.com

7209350100R07



Table of Contents

 Welcome & Congratulations	3
 IMPORTANT INSTRUCTIONS	4
 Fireplace Installation	7
 Operation	14
 Maintenance.	16
 Warranty	18
 Replacement Parts	20

Always use a qualified technician or service agency to repair this fireplace.

! NOTE: Procedures and techniques that are considered important enough to emphasize.

⚠ CAUTION: Procedures and techniques which, if not carefully followed, will result in damage to the equipment.

⚡ WARNING: Procedures and techniques which, if not carefully followed, will expose the user to the risk of fire, serious injury, or death.

Welcome & Congratulations

Thank you and congratulations for purchasing an electric fireplace from Dimplex. Please use our convenient online registration page to record your model and serial numbers for future reference at

www.dimplex.com/register

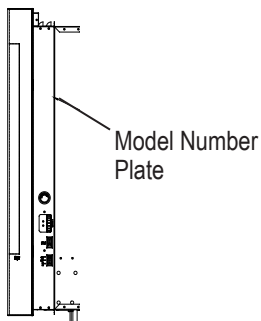

MODEL	<input type="text"/>	MOD.	<input type="text"/>
MODÈLE / MODELO			
SERIAL No.	<input type="text"/>	<input type="text"/>	<input type="text"/>
NUMÉRO DE SÉRIE / NÚMERO DE SERIE			

Please carefully read and save these instructions.

⚠ CAUTION: Read all instructions and warnings carefully before starting installation. Failure to follow these instructions may result in a possible electric shock, fire hazard and will void the warranty.



NO NEED TO RETURN TO THE STORE

Questions with operation or assembly? Require Parts Information?
Product Under Manufacturer's Warranty?

Contact us at:  **www.dimplex.com/customer_support**
For Troubleshooting and Technical Support

OR  **Toll-Free 1-888-DIMPLEX (1-888-346-7539)**

Monday to Friday 8:00 a.m. to 4:30 p.m. EST

In order to better serve you, please have your model and serial number ready or register your product online before calling (See above)

IMPORTANT INSTRUCTIONS

When using electrical appliances, basic precautions should always be followed to reduce the risk of fire, electric shock, and injury to persons, including the following:

- ① Read all instructions before using the Convex In-Stud fireplace.
- ② The heater is hot when in use. To avoid burns, do not let bare skin touch hot surfaces. The trim around the heater outlet becomes hot during heater operation. Keep combustible materials, such as furniture, pillows, bedding, papers, clothes, and curtains at least three (3) feet (0.9 m) from the front of the unit and keep them away from the sides and rear.
- ③ Extreme caution is necessary when any heater is used by or near children or invalids and whenever the unit is left operating and unattended.
- ④ Always unplug the fireplace when not in use.
- ⑤ Do not operate any heater after it malfunctions. Disconnect power at the service panel and have the heater inspected by a reputable electrician before reusing.
- ⑥ Do not operate any unit with a damaged cord or plug, or if the heater has malfunctioned, or if the electric fireplace has been dropped or damaged in any manner, contact Dimplex Technical Service at 1-888-346-7539.
- ⑦ Do not use outdoors.
- ⑧ Never locate heater where it may fall into a bathtub or other water container.
- ⑨ Do not run the cord under carpeting (for units supplied with a cord). Do not cover cord with throw rugs, runners, or the like. Arrange cord away from traffic area and where it will not be tripped over.
- ⑩ To disconnect the unit, turn the controls off, and then remove the plug from the outlet or switch off at main power supply panel if the unit is hard wired.
- ⑪ Do not insert or allow foreign objects to enter any ventilation or exhaust opening as this may cause an electric shock or fire, or damage to the heater.
- ⑫ To prevent a possible fire, do not block air intake or exhaust in

IMPORTANT INSTRUCTIONS

any manner.

⑬ All electrical heaters have hot and arcing or sparking parts inside. Do not use in areas where gasoline, paint, or flammable liquids are used or stored.

⑭ Do not modify the fireplace. Use it only as described in this manual. Any other use not recommended by the manufacturer may cause fire, electric shock or injury to persons.

⑮ This unit may have a polarized plug (one blade is wider than the other). The plug will fit in a polarized outlet only one way. If the plug does not fit fully in the outlet, reverse the plug. If it still does not fit, contact a qualified electrician to install the proper outlet.

⑯ Always plug heaters directly into a wall outlet/receptacle. Never use with an extension cord or relocatable power tap (outlet/power strip).

⑰ Do not burn wood or other materials in the fireplace.

⑱ Do not strike the glass front.

⑲ Always use a certified electrician for build-in hard-wired installation.

⑳ Always use properly grounded, fused and polarized outlets.

㉑ Disconnect all main power supply (unplug the unit or switch off at main service panel) before performing any cleaning, maintenance or relocation of the unit.

㉒ Do not operate the fireplace without the glass assembly and/or frame.

㉓ When transporting or storing the unit and cord, keep in a dry place, free from excessive vibration and store so as to avoid damage.

㉔ Do not put combustible material, liquid, or small articles such as sand inside glass assembly.



CAUTION
RISK OF ELECTRIC SHOCK
DO NOT OPEN

NO USER-SERVICEABLE PARTS INSIDE



SAVE THESE INSTRUCTIONS

IMPORTANT INSTRUCTIONS

 **WARNING:** Remote control contains small batteries. Keep away from children. If swallowed, seek medical attention immediately.

 **WARNING:** Do not install battery backwards, charge, put in fire or mix with used or other battery types - may explode or leak causing injury.

! **NOTE:** Changes or modifications not expressly approved by the party responsible for compliance could void user's authority to operate the equipment.

 **CAUTION:** This equipment has been tested and found to comply with the limits for Class B digital device, pursuant to part 15 of the FCC Rules. These limits are designed to provide reasonable protection against harmful interference in a residential installation. This equipment generates, uses and can radiate radio frequency energy and, if not installed and used in accordance with the instructions, may cause harmful interference to radio or television reception, which can be determined by turning the equipment off and on, the user is encouraged to try to correct the interference by one or more of the following measures:

- Reorient or relocate the receiving antenna.
- Increase the separation between the equipment and the receiver.
- Connect the equipment into an outlet on a circuit different from that to which the receiver is connected.
- Consult the dealer or an experienced radio/TV technician for help.

Operation is subject to the following two conditions: (1) this device may not cause interference and (2) this device must accept any interference, including interference that may cause undesired operation of the device.

Fireplace Installation

⚠ WARNING: Ensure the power cord is not installed so that it is pinched or against a sharp edge and ensure that the power cord is stored or secured to avoid tripping or snagging to reduce the risk of fire, electric shock or injury to persons.

⚠ WARNING: Construction and electrical outlet wiring must comply with local building codes and other applicable regulations to reduce the risk of fire, electric shock and injury to persons.

⚠ WARNING: Do not attempt to wire your own new outlets or circuits. To reduce the risk of fire, electric shock or injury to persons, always use a licensed electrician.

⚠ WARNING: To reduce the risk of fire, do not store or use gasoline or other flammable vapors or liquids in the vicinity of the heater.

! NOTE: A 15amp, 120-volt circuit is required. A dedicated circuit is preferred but not essential in all cases. A dedicated circuit will be required if, after installation, the circuit breaker trips or the fuse blows on a regular basis when the heater is operating. Additional appliances on the same circuit may exceed the current

rating of the circuit breaker.

⚠ WARNING: The Convex In Stud fireplace is wall mountable and can be built in a wall space 16" (406 mm) over-center between 2" (51 mm) x 4" (102 mm) wall studs. Follow the installation instructions for either wall mount or built-in mounting; failure to do so may cause damage or injury.

⚠ CAUTION: High temperature, risk of fire, keep electrical cords, drapery, furnishings, and other combustibles at least 3 feet (0.9 m) from the front of the heater.

Wall Mounting Instructions

1. Leave the glass assembly uninstalled until step 10.
2. Select a location for the fireplace, preferably above an electrical outlet and there must be at least one wall stud behind for the fireplace to mount onto. The bottom of the unit must be a minimum of 14" (356 mm) above the floor (mounting holes 29 $\frac{3}{4}$ " (0.75 m) minimum above the floor) (Figure 2).

Access to the electrical outlet

Fireplace Installation

must be maintained. Ensure the installation meets the national and state/provincial electrical codes.

! NOTE: It is recommended that the bottom of the unit not be mounted higher than 48" (1.22 m) from the ground to maintain an optimized viewing angle of the flame.

⚠ CAUTION: The fireplace must be mounted at two points, one of which must be on a wall stud.

⚠ WARNING: High temperatures may be generated under certain abnormal conditions. Do not partially or fully cover or obstruct the bottom of this heater. Bottom of unit must be a minimum of 14" (356 mm) above the floor or any surface such as a tabletop to ensure adequate space for heat exhaust from the bottom of the fireplace (Figure 3).

3. With a wall stud finder, locate the center of the wall stud, drive a wood screw into the stud and leave approximately $\frac{1}{8}$ " (3 mm) exposed threads for the fireplace to hang on.
4. The second mounting point should be picked such that it is farthest (to the left or right) relative to the first one among

Figure 2

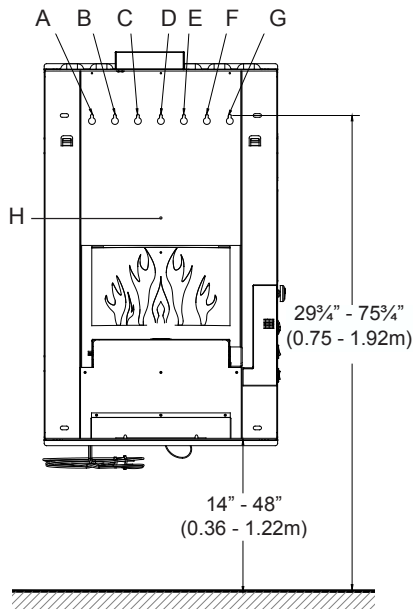

the seven (7) keyholes (A to G shown in Figure 2) on the fireplace for wall mounting, these keyholes are 2" (51 mm) apart. For example, if you plan to use hole B as the first mounting hole, the second mounting hole must be G.

Other available combinations are A-G, C-G, A-F, A-E, A-D and D-G.

5. Mark the second mounting

Fireplace Installation

screw location; ensure that it is level with the first with the help of the provided bubble level and the fireplace itself. Screw the threaded drywall anchor in the drywall with a Philip's head screwdriver until the head is flat against the wall surface.

Caution should be taken when using a power tool to install a threaded drywall anchor as the drywall may distort, tear or slightly buckle as a result of over-torque.

6. With a Philip's head screw driver, screw the drywall anchor screw into the drywall anchor already in the wall, leave $\frac{1}{8}$ " (3 mm) exposed

Figure 3

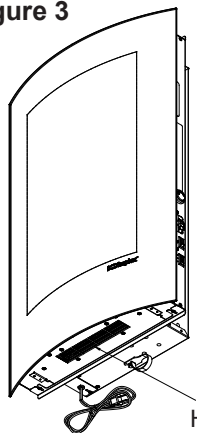

Heat Exhaust

threads for mounting the fireplace.

7. With the glass assembly taken off, mount the firebox onto the two mounting screws.
8. Mark position of hole "H".
9. Remove fireplace from wall.
10. Install drywall anchor into drywall at marked position.
11. With the glass assembly off, mount the fireplace onto the two mounted screws.
12. Tighten both mounting screws with a screwdriver. Be careful not to over tighten the screws mated with the drywall anchor.
13. Secure Philip's screw into drywall anchor, already in the wall (H).
14. Open the bag of pebbles and gently pour through top opening of front glass assembly.
15. Install glass assembly as shown in Figure 4.

Built-In Instructions

⚠ WARNING: The installation of the fireplace unit must comply with the applicable local and/or national electrical codes and utility requirements. This in-

Fireplace Installation

Installation should be entrusted to duly qualified personnel where required by law.

! NOTE: If the desired fireplace location is on the interior of an exterior wall the unit should only be surface mounted. If a in-wall or flush mount look is desired build the interior wall out into the room.

1. Leave the frame uninstalled from the fireplace chassis until step 13.
2. Prepare a wall opening following the dimensions shown in Figure 5. Note that a 4" (102 mm) minimum depth

including the thickness of dry wall is required. Make sure there is enough clearance for the cable coming out from the bottom of the fireplace.

! NOTE: Where there are close tolerances involved in wall building or applications which require a great degree of precision, we recommend that the product itself be used to make the actual measurements for the wall opening. Dimplex North America will not be responsible for inaccuracies in the design or manufacture of enclosures.

⚠ WARNING: Ensure method of

Figure 4

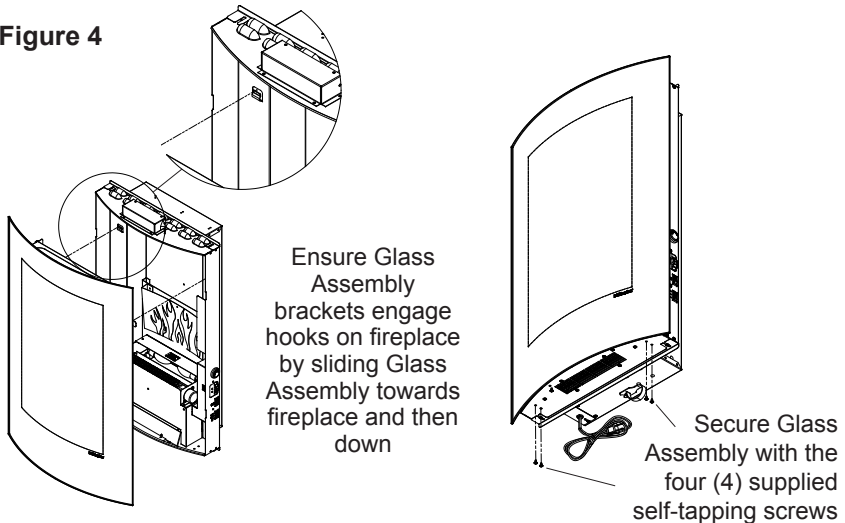

Fireplace Installation

installation does not obscure the air intake slots on top of unit in any manner.

Keep a minimum of a 4" (102 mm) clearance from top of unit to any surface or material.

3. Wire a dedicated, properly fused circuit with 120 Volt, 15 Amp rating. Allow up to 8' (2.44 m) of service cable for connecting power supply to junction box on fireplace when installing after finishing wall.

⚠ CAUTION: Use a two conductor, non-metallic sheath cable with ground wire (three wires total) for the incoming power supply on fireplace inserts.

Use the appropriate wire to meet local and national electrical codes for rated power consumption.

Figure 5

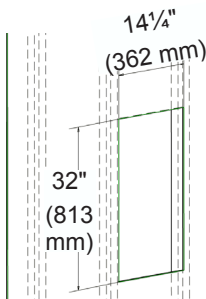

4. Remove the outer jacket and strip the individual conductor from the end.
5. Loosen the screw securing the junction box cover and remove the cover.
6. Take the cables out from the junction box, loosen the two wire nuts and remove the cord set (Figure 6).
7. Route the power supply wire through the knockout on supplied alternative junction box cover and secure with a wire clamp (not supplied) (Figure 7).
8. Connect the black wire (live) from the unit to the black wire from power supply (Figure 7).
9. Connect the white wire (neutral) from the unit to the white wire from power supply (Figure 7).
10. Connect the green wire (ground) from the unit to the green wire from power supply (Figure 7).
11. Place all connectors inside the unit and secure the junction box cover to unit. Ensure that the cable clamp grips only the jacket of service

Fireplace Installation

cable.

! NOTE: All wiring must be completed prior to installing the unit into the wall.

- Place unit in position in the opening, push straight in and attach unit to studs using No. 10 fasteners (not included) (Figure 8).
- Attach supplied wall cover brackets to the top and the bottom of fireplace to cover the gap on the dry wall (Figure 9).
- Attach fireplace frame as shown in Figure 4.

Bathroom Installation

This firebox must be protected by a GFI receptacle or circuit for bathroom use. If receptacle is used it must be readily accessible.

This unit is an electrical appliance that is not watertight and must be installed as to prevent water from entering the unit to prevent electrical shock. This unit must be installed away from showers, tubs, etc.

Never locate fireplace where it may fall into a bathtub or other water containers. Keep towels

Figure 6

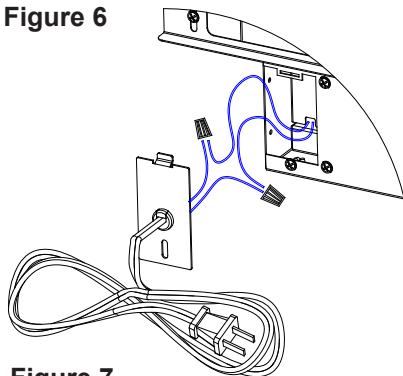
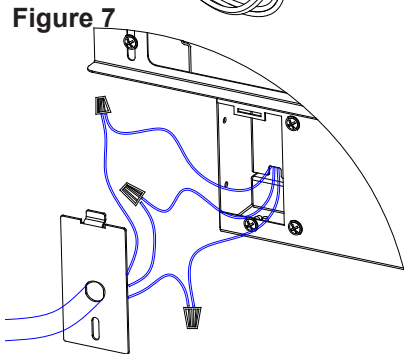

Figure 7



and other combustible materials 3 ft (0.9 m) away from the bottom of the unit.

Fireplace Installation

Figure 8

Add wood screws here

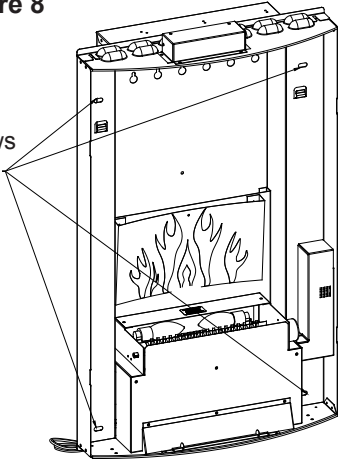
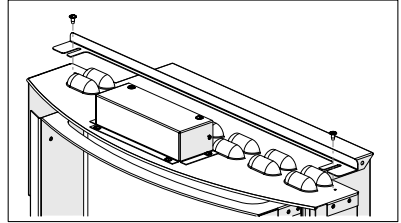
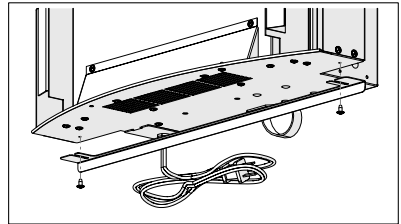

Figure 9

Top Bracket



Bottom Bracket



WIRING

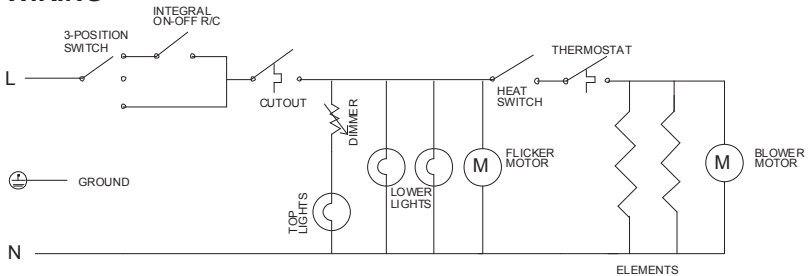

🔑 Operation

Figure 10

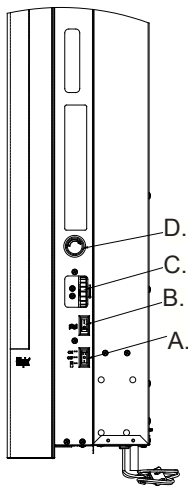

⚠️ WARNING: This electric firebox must be properly installed before it is used.

Manual Controls

The controls are located on the right hand side of the fireplace (Figure 10).

A. 3-Position Switch

The switch has two ON positions marked with  and "ON".

The "ON" position is for manual operation. In this position the built-in remote control is by-passed.

The  position is for operating the unit with the provided remote control.

When in  position the unit is operated with the ON and OFF buttons of the remote control.

When the switch is in the center position the unit is off.

B. Heater On/Off Switch

The Heater On/Off Switch supplies power to the heater fan and the heater element.

When the switch is in the ON position the heater operates if the thermostat calls for heat.

! NOTE: The heater may emit a slight, harmless odor when first used. This odor is a normal condition caused by the initial heating of internal heater parts.

C. Heater Thermostat Control

To adjust the temperature to your individual requirements, turn the thermostat control upward all the way to turn on the heater. When the room reaches the desired temperature, turn the thermostat knob downward until you hear a click. Leave in this position to maintain the room temperature at this setting. For additional heat, turn upward until you hear the click again and the heater will turn on.

👉 Operation

D. Top Light Dimmer Control

The top Top Light Dimmer Control controls the brightness of the top accent light that is used to illuminate the pebbles.

Resetting The Temperature Cutoff Switch

Should the heater overheat, an automatic cut out will turn the fireplace off and it will not come back on without being reset. It can be reset by switching the 3-Position Switch to OFF and waiting five minutes before switching the unit back on.

⚠ CAUTION: If you need to continuously reset the heater, disconnect power and call Dimplex customer service at 1-888-DIMPLEX (1-888-346-7539).

Remote Control

The fireplace is supplied with an integrated on/off remote control

! NOTE: Ensure that the fireplace 3-Position Switch is set to the remote control setting.

To operate, push the ON button to turn fireplace on, push the OFF button to turn the fireplace off.

! NOTE: Before attempting any operation with the remote control,

pull the plastic insulator strip out from between the remote casing and battery cover.

Remote Control Initialization/ Reprogramming

15. Disconnect power to fireplace.
16. Wait a minimum of 5 seconds and then re-acquire power to fireplace.
17. Within 10 seconds of re-acquiring power, press the On button located on the remote control.

This will synchronize the remote control and receiver.

Battery Replacement (Figure 11)

To replace the battery:

1. Slide battery cover open on the remote control.

Figure 11

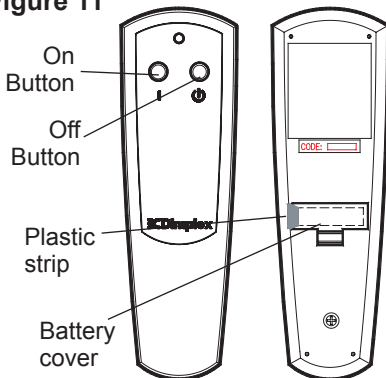

Operation

2. Install one 12 Volt (A23) battery in the battery holder.
3. Close the battery cover.



Battery must be recycled or disposed of properly. Check with your Local Authority or Retailer for recycling advice in your area.



Maintenance

⚠ WARNING: Disconnect power and heater has cooled before attempting any maintenance or cleaning to reduce the risk of fire, electric shock or damage to persons.

! NOTE: The fireplace should not be operated with an accumulation of dust or dirt on or in the unit, as this can cause a build up of heat and eventual damage. For this reason the heater must be inspected regularly, depending upon conditions and at least at yearly intervals.

Light Bulb Replacement

Light bulbs need to be replaced when you notice a dark section of the flame. There are two bulbs, which generate the flames.

Helpful Hints: It is a good idea to replace all light bulbs at once if they are close to the end of their rated life. Group replacement will

reduce the number of times you will need to open the unit to replace light bulbs.

Light Bulb Requirements:

Quantity of two 60 Watt chandelier or candelabra bulbs with E-12 (small) socket base, 120 Volt. **Do not exceed 60 Watt per bulb**

Bulb Replacement Instructions:

⚠ CAUTION: Turn unit off, allow at least 5 minutes for light bulbs to cool before touching bulbs to avoid accidental burning of skin.

1. Disconnect power supply to the fireplace either by unplugging the fireplace or switch off at the breaker panel.
2. Remove glass assembly. Remove the screws securing the glass assembly on the chassis (Figure 4).
3. Hold on to the glass assembly with both hands then lift the whole assembly straight up to



Maintenance

Figure 12

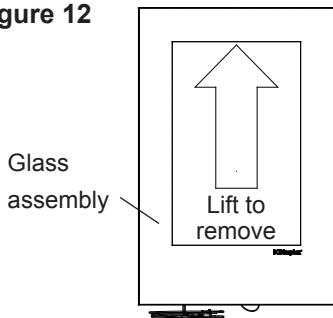

remove (Figure 11).

4. Remove the two screws securing the light block as shown in Figure 13, then remove the light block.
5. Reach in and turn the burnt bulb(s) counterclockwise to remove.
6. Replace with new bulbs.
7. Reassemble light block and glass assembly in reverse order.

Glass Cleaning

The front glass is cleaned in the factory during the assembly operation. During shipment, installation, handling, etc., the front glass may collect dust particles, these can be removed by dusting lightly with a clean dry cloth.

To remove fingerprints or other marks, the glass can be cleaned

Figure 13

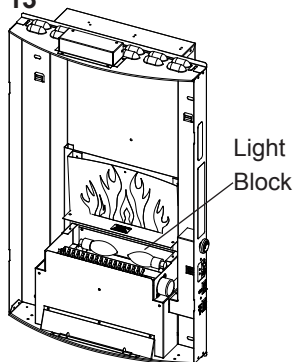

with a damp cloth. The glass should be completely dried with a lint free cloth to prevent water spots. To prevent scratching, do not use abrasive cleaners or spray liquids on the glass surface.

Fireplace Surface Cleaning

To remove fingerprints or other marks, the exterior finish can be cleaned with a damp cloth with a mild detergent. The surface should be completely dried with a lint free cloth to prevent water spots. To prevent scratching, do not use abrasive cleaners or spray liquids on any surface.

Servicing

Except for light bulb replacement and cleaning described above, an authorized service representative should perform any other servicing.



Warranty

Products to which this limited warranty applies

This limited warranty applies to the following models of your newly purchased Dimplex electric fireplace **VCX1525** and to newly purchased Dimplex fireplace surrounds and trims. This limited warranty applies only to purchases made in any province of Canada except for Yukon Territory, Nunavut, or Northwest Territories or in any of the 50 States of the USA (and the District of Columbia) except for Hawaii and Alaska. This limited warranty applies to the original purchaser of the product only and is not transferable.

Products excluded from this limited warranty

Light bulbs are not covered by this limited warranty and are the sole responsibility of the owner/purchaser. Products purchased in Yukon Territory, Nunavut, Northwest Territories, Hawaii, or Alaska are not covered by this limited warranty. Products purchased in these States, provinces, or territories are sold AS IS without warranty or condition of any kind (including, without limitation, any implied warranties or conditions of merchantability or fitness for a particular purpose) and the entire risk of as to the quality and performance of the products is with the purchaser, and in the event of a defect the purchaser assumes the entire cost of all necessary servicing or repair.

What this limited warranty covers and for how long

Products, other than fireplace surrounds (mantels) and trims, covered by this limited warranty have been tested and inspected prior to shipment and, subject to the provisions of this warranty, Dimplex

warrants such products to be free from defects in material and workmanship for a period of 1 year from the date of the first purchase of such products.

The limited 1 year warranty period also applies to any implied warranties that may exist under applicable law. Some jurisdictions do not allow limitations on how long an implied warranty lasts, so the above limitation may not apply to the purchaser.

What this limited warranty does not cover

This limited warranty does not apply to products that have been repaired (except by Dimplex or its authorized service representatives) or otherwise altered. This limited warranty does further not apply to defects resulting from misuse, abuse, accident, neglect, incorrect installation, improper maintenance or handling, or operation with an incorrect power source.

What you must do to get service under this limited warranty

Defects must be brought to the attention of Dimplex Technical Service by contacting Dimplex at 1-888-DIMPLEX (1-888-346-7539), or 1367 Industrial Road, Cambridge Ontario, Canada N1R 7G8. Please have proof of purchase, catalogue/model and serial numbers available when calling. Limited warranty service requires a proof of purchase of the product.

What Dimplex will do in the event of a defect?

In the event a product or part covered by this limited warranty is proven to be defective in material or workmanship during the 1 year limited warranty period you have the following rights:

- Dimplex will in its sole discretion either repair or replace such defective prod-



Warranty

uct or part without charge. If Dimplex is unable to repair or replace such product or part, or if repair or replacement is not commercially practicable or cannot be timely made, Dimplex may, in lieu of repair or replacement, choose to refund the purchase price for such product or part.

- This limited warranty does not entitle the purchaser to on-site or in-home services. On-site or in-home services may be performed at the purchaser's specific request and expense at Dimplex's then-current rates for such services.
- Limited warranty service will be performed solely by dealers or service agents of Dimplex authorized to provide limited warranty services.
- Dimplex will not be responsible for, and the limited warranty services shall not include, any expense incurred for installation or removal of the product or part (or any replacement product or part) or any labour or transportation costs. Such costs shall be the purchaser's responsibility.

What Dimplex and its dealers and service agents are also not responsible for:

IN NO EVENT WILL DIMPLEX, OR ITS DIRECTORS, OFFICERS, OR AGENTS, BE LIABLE TO THE PURCHASER OR ANY THIRD PARTY, WHETHER IN CONTRACT, IN TORT, OR ON ANY OTHER BASIS, FOR ANY INDIRECT, SPECIAL, PUNITIVE, EXEMPLARY, CONSEQUENTIAL, OR INCIDENTAL LOSS, COST, OR DAMAGE ARISING OUT OF OR IN CONNECTION WITH THE SALE, MAINTENANCE, USE, OR INABILITY TO USE THE PRODUCT, EVEN IF DIMPLEX

OR ITS DIRECTORS, OFFICERS, OR AGENTS HAVE BEEN ADVISED OF THE POSSIBILITY OF SUCH LOSSES, COSTS OR DAMAGES, OR IF SUCH LOSSES, COSTS, OR DAMAGES ARE FORESEEABLE. IN NO EVENT WILL DIMPLEX, OR ITS OFFICERS, DIRECTORS, OR AGENTS BE LIABLE FOR ANY DIRECT LOSSES, COSTS, OR DAMAGES THAT EXCEED THE PURCHASE PRICE OF THE PRODUCT.

SOME JURISDICTIONS DO NOT ALLOW THE EXCLUSION OR LIMITATION OF INCIDENTAL OR CONSEQUENTIAL DAMAGES, SO THE ABOVE LIMITATION OR EXCLUSION MAY NOT APPLY TO THE PURCHASER.

How State and Provincial law apply

This limited warranty gives you specific legal rights, and you may also have other rights which vary from jurisdiction to jurisdiction. The provisions of the United Nations Convention on Contracts for the Sale of Goods shall not apply to this limited warranty or the sale of products covered by this limited warranty.



Replacement Parts

Front Glass - VCX1525	5901170100RP
VCX1525-WH	5901170200RP
Flicker Motor	2000500100RP
Flicker Rod	5901110100RP
Lampholder	4200090200RP
Mirror	5901180100RP
Thermostat	2300150100RP*
Heater On/Off Switch	2800070700RP
Thermostat Control Knob	8801080100RP
3-Position Switch	2800071100RP
Remote Control Receiver	3000380200RP
Heater Assembly	6904280200RP
Cutout	2300201200RP
Cord Set	4100090200RP
Wire Harness	2500400400RP
Dimmer Control	3000250100RP
Dimmer Control Knob	8800000600RP
Remote Control	3000370500RP
Media Tray Retaining Bracket	1020410159RP
Black Stone Media	1400050100RP
River Rock Media (VCX1525WH)	1400080100RP



Dimplex North America Limited
1367 Industrial Road
Cambridge ON
Canada N1R 7G8

© 2015 Dimplex North America Limited